

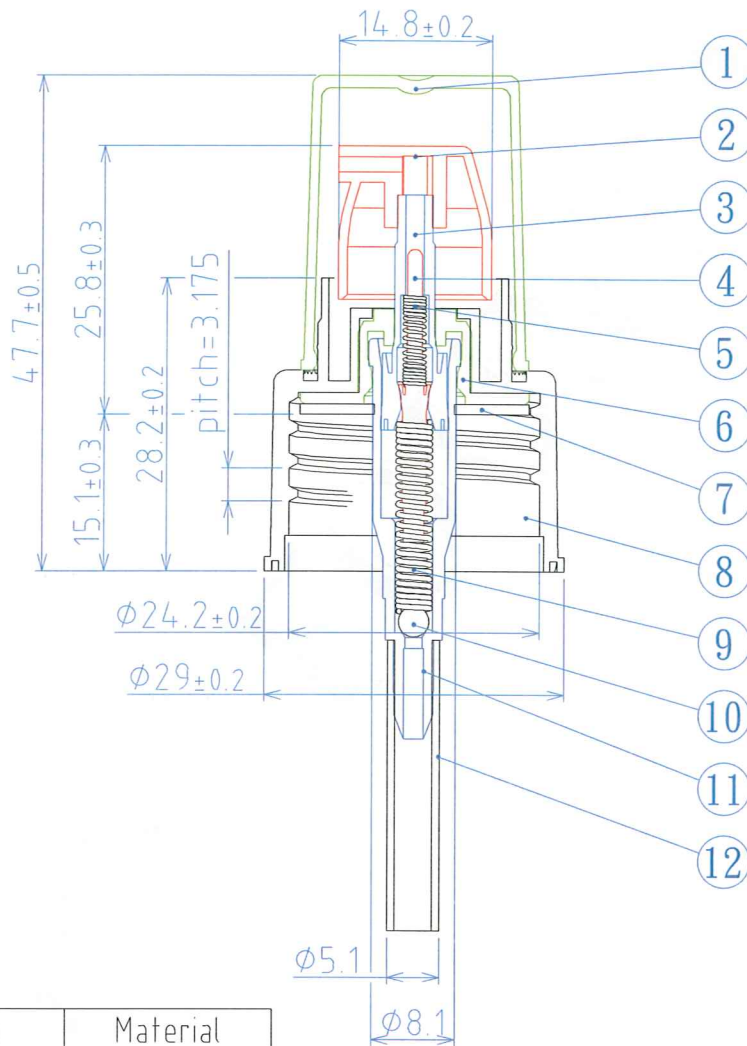

0.16cc Lotion Pump L-24(小蓋)



Item	Description	Material
1	Small Cap	PP
2	Actuator	PP
3	Piston	PE
4	Poppet	PE
5	Main Spring	Stainless Steel
6	Flange	PE
7	Gasket	TPR
8	Screw Cap (24/410)	PP
9	Return Spring	Stainless Steel
10	Ball	Stainless Steel
11	Body	POM
12	Dip-tube	P.E

Date	2018/01/26
Drawing No.	l24-b1-24002

* 此圖面在未經許可下請勿實行"拷貝"及"製作".