

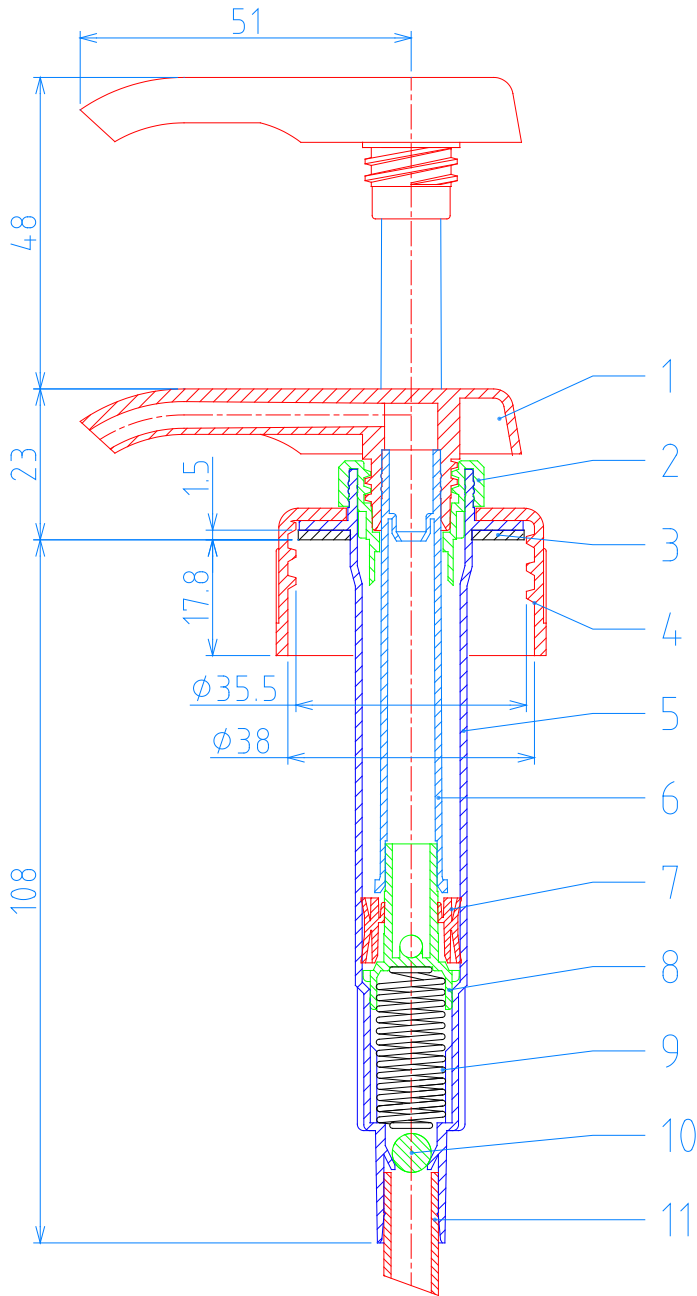

8.0cc Dispenser Pump(DP-802)

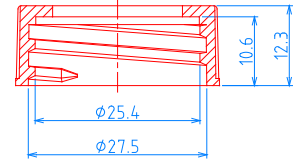

(28/400) CAP , P=1"x6 TPI



(28/400) CAP , P=1"x8 TPI

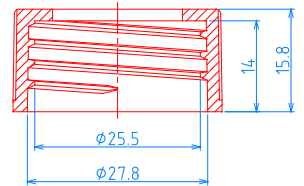

(28/410) CAP , P=1"x6 TPI

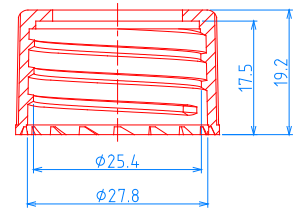

(38/400) CAP , P=1"x8 TPI

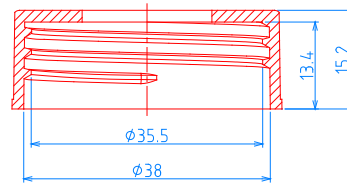

(28/415) CAP , P=1"x6 TPI

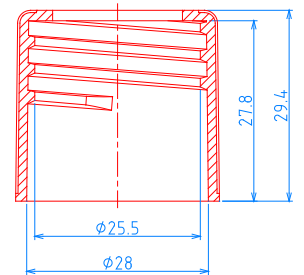

(38/400) CAP , P=1"x6 TPI

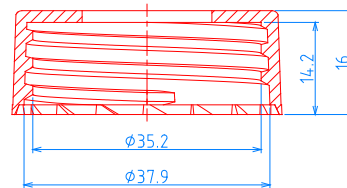

(30/400) CAP , P=1"x8 TPI

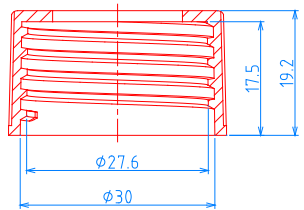

(38/410) CAP , P=1"x6 TPI

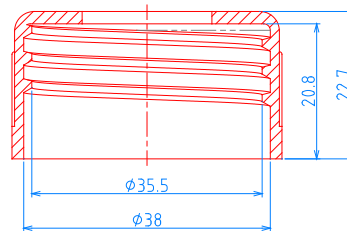

(33/410) CAP , P=1"x6 TPI

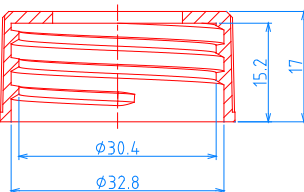

| Item | Description | Material |
|------|------------------|----------|
| 1 | 按頭 ACTUATOR | PP |
| 2 | 結合蓋 CHAPLET | PP |
| 3 | 墊片 GASKET | LDPE |
| 4 | (38/410)牙蓋 CAP | PP |
| 5 | 缸體 HOUSING | PP |
| 6 | 活塞桿 PLUNGER | PP |
| 7 | 活塞環 PISTON RING | LDPE |
| 8 | 活塞座 PISTON BASE | HDPE |
| 9 | 彈簧 SPRING | SUS-304 |
| 10 | 塑膠珠 PLASTIC BALL | ABS |
| 11 | 吸管 TUBE | LDPE |