

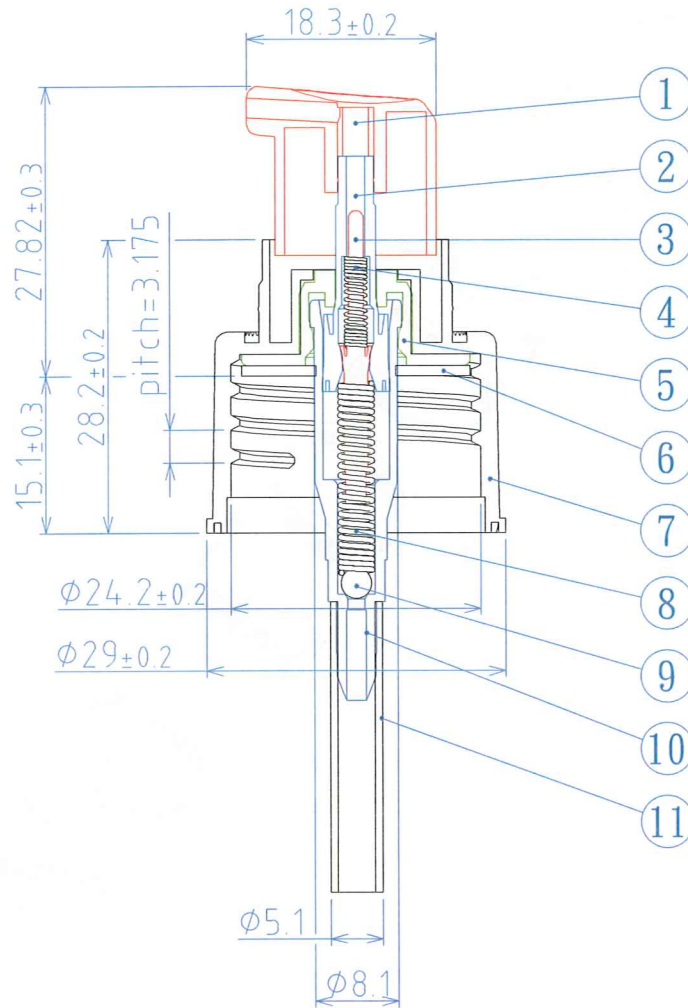

0.16cc Lotion Pump L-24(加大蓋)



Item	Description	Material
1	Actuator	PP
2	Piston	PE
3	Poppet	PE
4	Main Spring	Stainless Steel
5	Flange	PE
6	Gasket	TPR
7	Screw Cap (24/410)	PP
8	Return Spring	Stainless Steel
9	Ball	Stainless Steel
10	Body	POM
11	Dip-tube	P.E

Date	2018/01/23
Drawing No.	124-b1-24001

* 此圖面在未經許可下請勿實行"拷貝"及"製作".